

PADIVA_CONN1

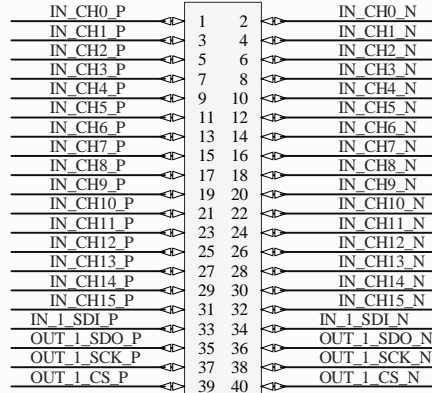

KEL8630E-040S-P_0.635mm
SPLIT_OUTPUT1

PADIVA_CONN2

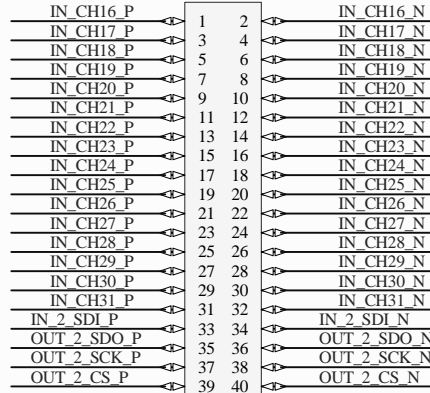

KEL8630E-040S-P_0.635mm
SPLIT_OUTPUT2

PADIVA_CONN3

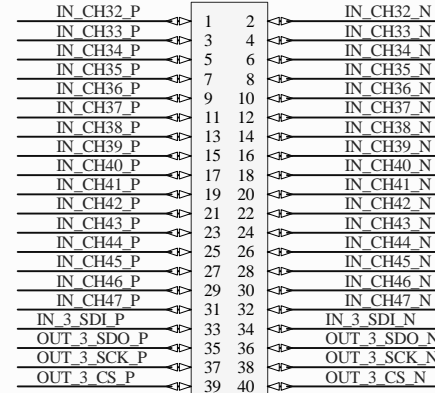

KEL8630E-040S-P_0.635mm
SPLIT_OUTPUT3

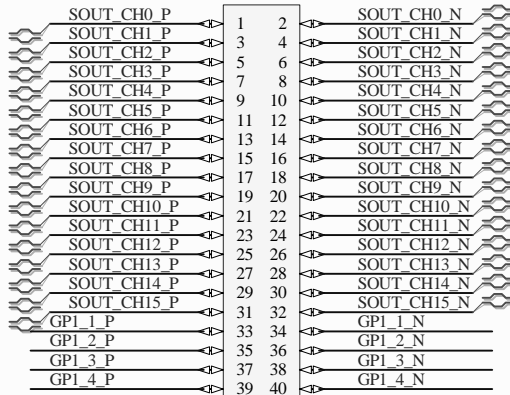

KEL8630E-040S-P_0.635mm

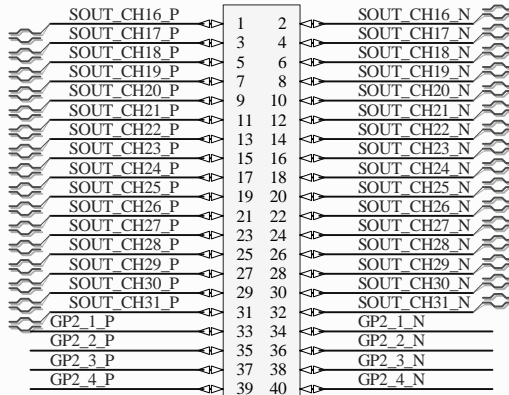

KEL8630E-040S-P_0.635mm

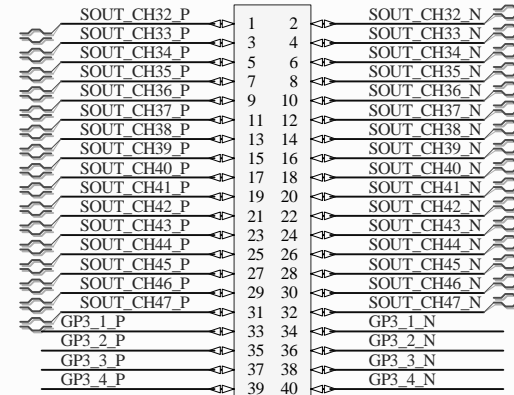

KEL8630E-040S-P_0.635mm

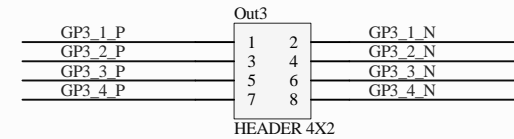
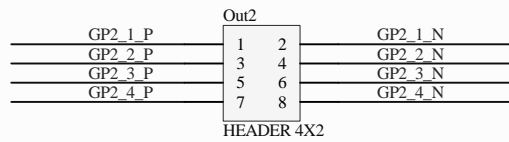
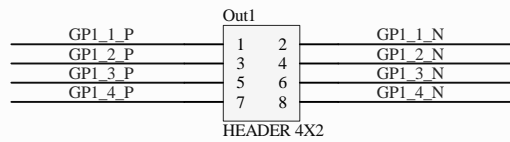

Title		
Size A4	Number	Revision
Date:	2016-02-17	Sheet of
File:	C:\Program Files (x86)\..\padiva_connectors\BhdDoBy	

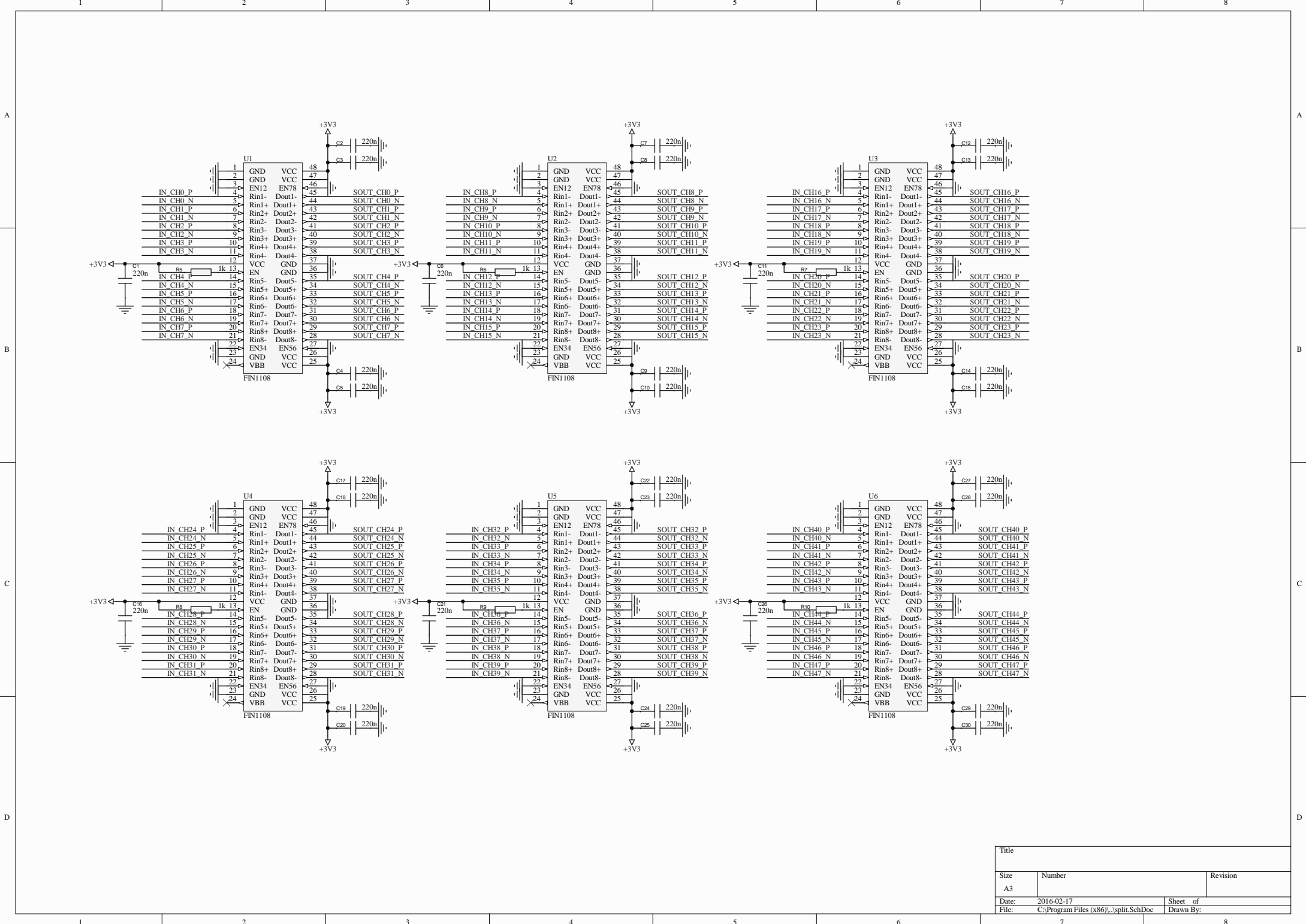

Title		
Size	Number	Revision
A3		
Date:	2016-02-17	Sheet of
File:	C:\Program Files (x86)_split.SchDoc	Drawn By:

A

A

B

B

C

C

D

D

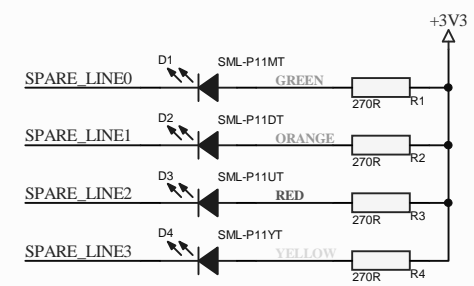
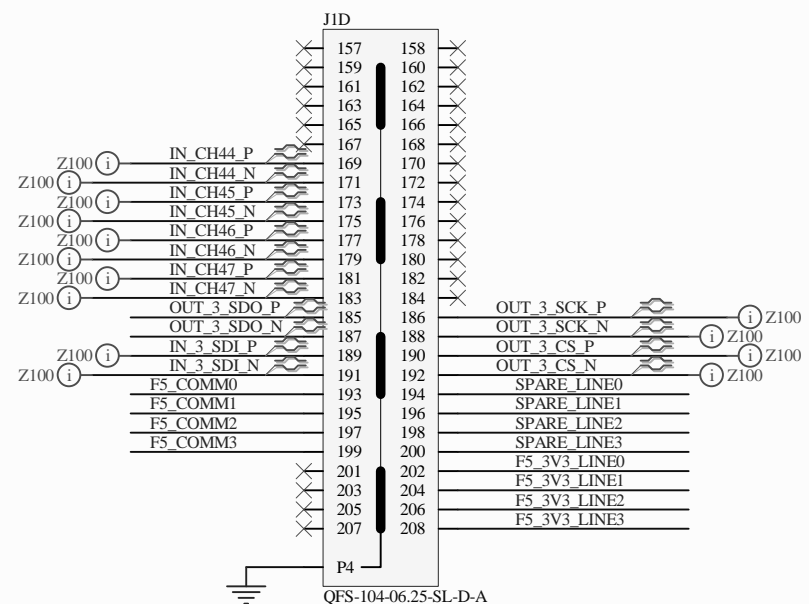
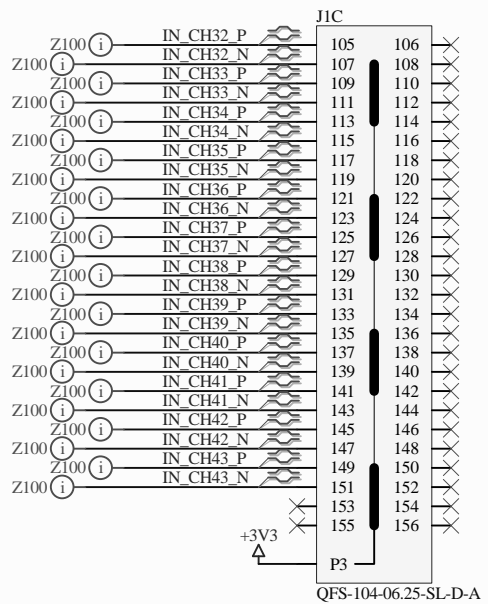
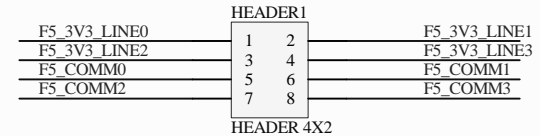
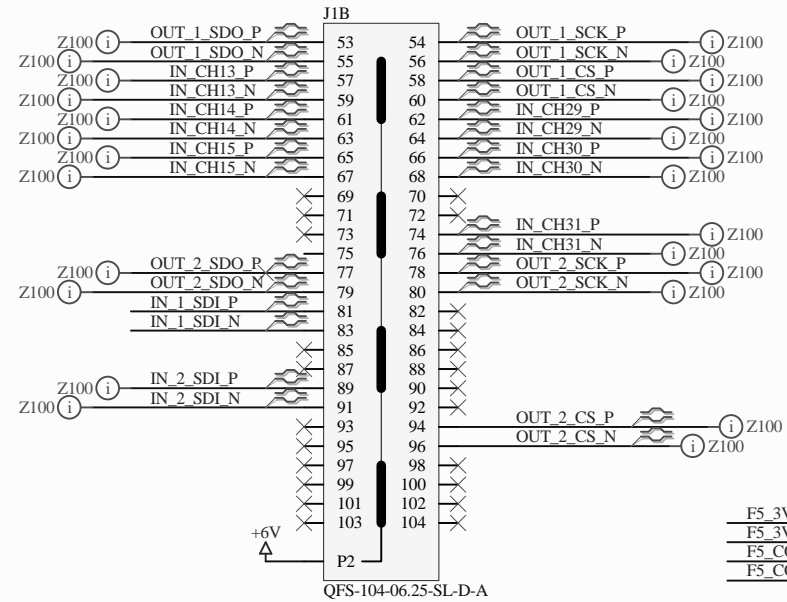
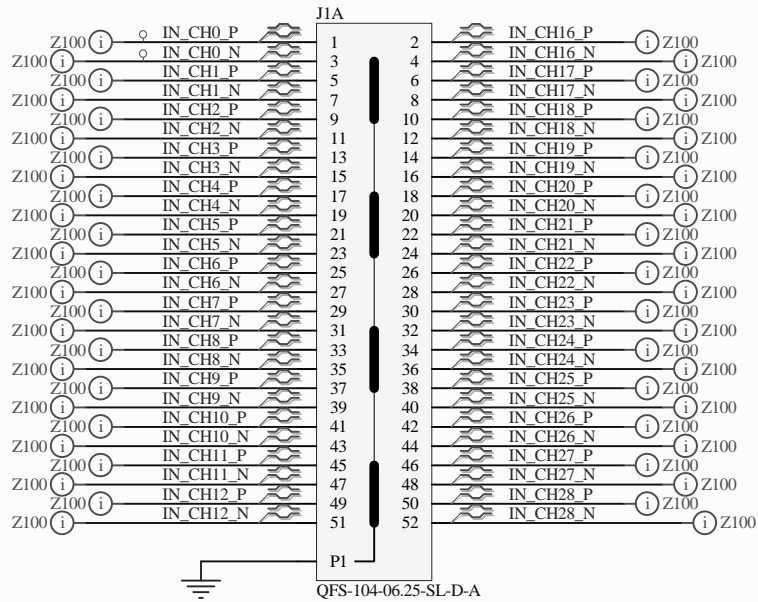

Title		
Size	Number	Revision
A4		
Date:	2016-02-17	Sheet of
File:	C:\Program Files (x86)\...trb_connector.Sch Drawn By:	